







## W/T配線器具

- 23-29 W/Tジャンクションボックス・スイッチ・レセツプ
- 24 レセツプインテリア
- 27 プラグインテリア
- 29 CEEプラグ・カップリンク
- 31 防爆器具
- 31A モールス信号灯
- 32 カーゴソケットブリティッシュ・スウェーデン
- 33-37 ロータリースイッチ
- 38 プラスランプホルダ
- 39-40 防水蛍光灯器具・安定器
- 40-43 FLランプホルダ
- 40 スターター
- 43 プラグアダプター
- 44-47 非防水配線器具
- 48-50 ターミナルストリップ・ホーセレンターミナル
- 51-52 ターミナルブロック
- 53-54 グラント
- 55 ケーブルクリップ
- 56-60 その他

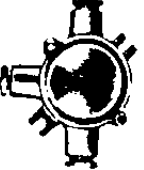
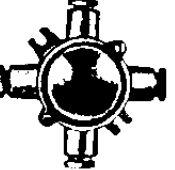
EUROPEAN ELECTRICAL EQUIPMENT FOR SHIPSWATERTIGHT HNA-CABLE JUNCTION BOXES

				<u>ORDER NO.</u>			
Two cable entry	16A, 500V	1150	¥ 5,260		1150		
" " "	" "	1151	¥ 5,260				
Three "	" "	1152	¥ 6,050		1151		
Four "	" "	1153	¥ 7,040				
Three "	" "	1154	¥ 6,050				
Four "	" "	1155	¥ 7,040		1152		
Two cable entry	" "	1150/MS	¥ 5,420				
" " "	" "	1151/MS	¥ 5,420				
Three "	" "	1152/MS	¥ 6,360		1153		
Four "	" "	1153/MS	¥ 7,310				
Three "	" "	1154/MS	¥ 6,360				
Four "	" "	1155/MS	¥ 7,310		1154		
Terminal Block	10A	181	¥ 1,160		1155		

WATERTIGHT HNA-SWITCHES (Single-pole)

One cable entry	10A, 250V	1133	¥ 5,640				
Two " "	" "	1133-2	¥ 6,580				
" " "	" "	1133-D	¥ 6,580		1133-D		
" " "	" "	1138	¥18,100				
(with control light E14)							
One cable entry	" "	1133/MS	¥ 6,100				
Two " "	" "	1133-2MS	¥ 7,100		1138		
" " "	" "	1133-DMS	¥ 7,100				
" " "	" "	1138/MS	¥18,700				
(with control light E14)							

(From 1. Apr. 1982)

EUROPEAN ELECTRICAL EQUIPMENT FOR SHIPS

SPARE PARTS

ORDER NO.

Single-pole switch interior	1841	¥ 1,300
Double " " "	1842	¥ 1,940
Change over " "	1843	¥ 1,700
Multi-circuit " "	1844	¥ 1,700
Intermediate " "	1845	¥ 2,150

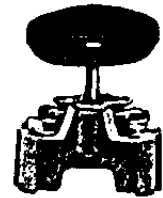

1841

WATERTIGHT HNA-SOCKETS

One cable entry	16A	220V	1141	¥ 9,240
Two " " " "			1141-2	¥10,200
" " " " "			1141-D	¥10,200
One " " " "			1141/MS	¥10,100
Two " " " "			1141-2/MS	¥10,970
" " " " "			1141-D/MS	¥10,970

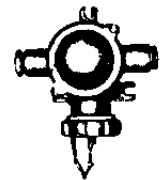

1141-D

SPARE PARTS

Terminal block	10A	181	¥ 1,160
Socket interior	110V	138/110	¥ 1,490
" " "	220V	138/220	¥ 1,490



181



138

WATERTIGHT HNA-SOCKETS WITH SWITCH

One cable entry	16A, 220V	1144	¥10,600
Two " " " "		1144-2	¥11,650
" " " " "		1144-D	¥11,650
One cable entry	" "	1144/MS	¥11,500
Two " " " "		1144-2/MS	¥12,450
" " " " "		1144-D/MS	¥12,450



1144-2

EUROPEAN ELECTRICAL EQUIPMENT FOR SHIPSWATERTIGHT HNA-CONCENTRIC SOCKET

					<u>ORDER NO.</u>	
One cable entry	10A,	42V			110	¥ 8,680
"	"	"	"	"	110-R	¥ 8,680
Two cable entry	"	"			110-2	¥ 9,650
"	"	"	"	"	110-2R	¥ 9,650
"	"	"	"	"	110-D	¥ 9,650
One cable entry	"	"			110/MS	¥ 9,310
"	"	"	"	"	110RMS	¥ 9,310
Two	"	"	"	"	110-2MS	¥10,230
"	"	"	"	"	110-2RMS	¥10,230
"	"	"	"	"	110-DMS	¥10,230

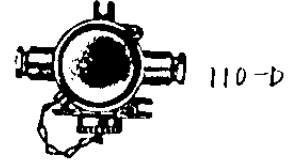
SPARE PARTS

Socket interior for Order No.110, 110-R, 110-2, 110-2R, 110-D	2110	¥ 1,600
--	------	---------

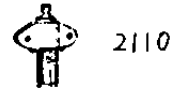
WATERTIGHT CONCENTRIC SOCKET BOX 10A



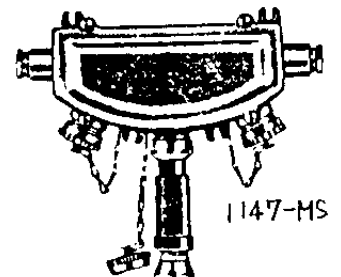

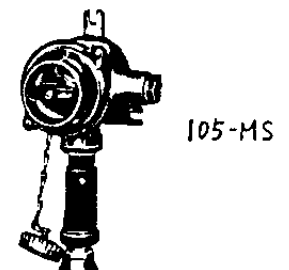

"Special-Shipsmodel" with 3 concentric socket interior casing and cover made of brass	1147	¥31,880
entirely made of brass	1147/MS	¥32,750

BRASS CONCENTRIC SOCKET WITH SWITCH

Two cable entry	10A,	42V	105-2	¥14,960
"	"	"	105-2/MS	¥15,250

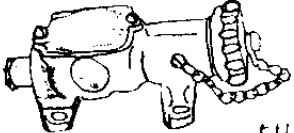

EUROPEAN ELECTRICAL EQUIPMENT FOR SHIPS

	<u>Order No.</u>		
<u>CONCENTRIC PLUG &amp; COUPLING 10A, 42V</u>			
Concentric plugs with securing ring	117	¥ 2,740	
Concentric coupling	122	¥ 6,080	
<u>ACCESSORIES</u>			
Plug interior for Order No.117	124	¥ 1,820	
Coupling interior for Order No.122	122/E	¥ 3,850	
<u>CONCENTRIC SOCKETS 10A, 42V</u>			
Iso-concentric sockets One cable entry	503	¥ 4,620	
Brass-socket with molded compound screw cap	5110	¥ 9,830	
Cast iron concentric sockets One cable entry	100	¥ 5,710	
Two cable entry	100-2	¥ 6,210	
" " "	100-D	¥ 6,210	
One cable entry and vertical plug inlet	100-V	¥ 6,430	
<u>SPARE PARTS FOR SOCKET</u>			
Socket interior for 503, 100, 100-2 100-D, 100-V and 1147	133	¥ 1,540	

EUROPEAN ELECTRICAL EQUIPMENT FOR SHIPS

WATERTIGHT HNA-PLUG 16A, 220V

	<u>ORDER NO.</u>	
Molded compound plug	1142	¥ 3,300
Brass plug	1142/MS	¥ 4 650 27

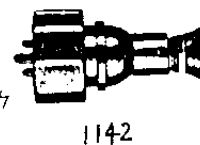

SPARE PARTS

Plug interior 110V	137/110	¥ 1,050
" " 220V	137/220	¥ 1,050



WATERTIGHT HNA-COUPPLINGS 16A, 220V

Molded compound coupling	1145	¥ 5,500
Brass coupling	1145/MS	¥ 7,100



WATERTIGHT HNA-SOCKET BOXES 16A. 220V 27 16A

Socket box for Two plugs	1143-2	¥27,000 (2)
" " " Three "	1143-3	¥34,290
Socket box for Two plugs	1143-2/MS	¥28,100
" " " Three "	1143-3/MS	¥35,800

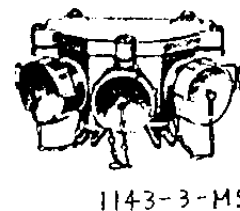

Socket for test board	1148	¥ 6,950
-----------------------	------	---------



WATERTIGHT LOCKING TYPE SOCKET SWITCHES FOR TANKERS

One cable entry	16A, 220V	1144-V	¥20,100
Two " "	" "	1144-2/V	¥20,950
One cable entry	" "	1144-V/MS	¥20,500
Two " "	" "	1144-2/V/MS	¥21,450
" " "	" "	1144-D/V/MS	¥21,450

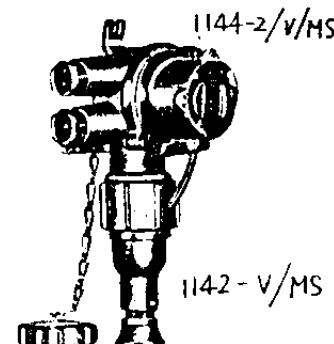

(From 1. Apr. 1982)

EUROPEAN ELECTRICAL EQUIPMENT FOR SHIPS

WATERTIGHT LOCKING TYPE PLUGS

	ORDER NO.	
Molded compound plug 16A. 220V	1142-V	¥ 4,650
Brass plug " "	1142-V/MS	¥ 6,550

MULTIPOLAR SOCKETS, 10A

4 pole contact one cable entry	2064	¥11,370
" " " " " "	2064/MS	¥12,370
" " " Two " "	2064-2	¥12,600
" " " " " "	2064-2/MS	¥13,600



2064-RMS

MULTIPOLAR PLUGS, 10A

Molded compound plug	2065	¥ 4,400
Brass plug (4 pole with earth)	2065/MS	¥ 5,500

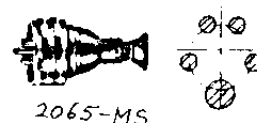

2065-MS

SPARE PARTS

Socket interior	138-5	¥ 2,750
Plug interior	137-5	¥ 2,530

MULTIPOLAR SOCKETS 42V

4 pole, 42V one cable entry	2072	¥16,150
" " " " " "	2072/MS	¥17,150



2072-MS

MULTIPOLAR PLUG & COUPLING

4 pole, 42V Brass plug	2073	¥ 9,460
" " " Brass coupling	2074	¥10,250



2073

CEE -BRASS POWER SOCKETS WITH SWITCH

ツマミの2

with locking mechanism	32A	32-L	¥51,250
" " "	63A	63-L	¥78,500



CEE-BRASS POWER PLUGS & COUPLING

3H

MOLDED COMPOUND PLUG 500V, 32A	32-ST	¥11,550
Brass plug " 32A	32-ST/MS	¥18,500
Molded compound plug " 63A	63-ST	¥15,700
Brass plug " 63A	63-ST/MS	¥44,550

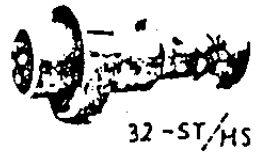

Molded compound coupling 32A	32/K/FS	¥18,200
------------------------------	---------	---------

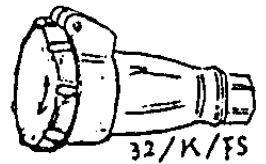

CEE-SPARE PARTS

Socket interior	32A	138-32	¥ 7,500
" "	63A	138-63	¥15,700
Switch "	32A	1832	¥13,100
" "	63A	1863	¥21,300
Plug interior	32A	137-32	¥ 7,500
" "	63A	137-63	¥14,500

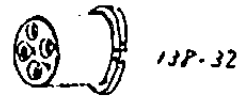

EUROPEAN ELECTRICAL EQUIPMENT FOR SHIPS

ORDER NO.

BRASS PUSH AND SIGNAL BUTTONS

Push button, single-pole	720-AR	¥10,380
" " " "	720-2AR	¥11,260
" " " "	720-DAR	¥11,260
Push button, with control light E14, single-pole	721-AR	¥17,230

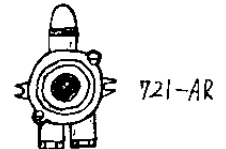
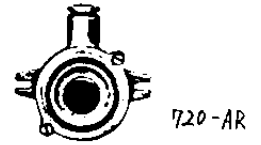

SPARE PARTS

for Order No.720 and 721

Interior with push button

Single-pole	AR	¥ 2,520
Double-pole	AA	¥ 3,670
" "	RR	¥ 3,670
Control light with bulb	1921	¥ 2,100

BRASS FIRE ALARM PUSH BUTTONS

Single-pole push buttons, hammer with chain	716	¥27,480
--	-----	---------

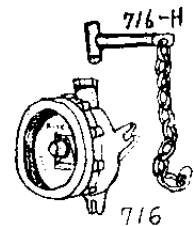

SPARE PARTS

for Order No.716

Hammer with chain	716-H	¥ 3,380
-------------------	-------	---------

BRASS EXPLOSIONPROOF SWITCH

Double-pole, 250V, 16A	E14 102/Mn	¥29,430
------------------------	------------	---------

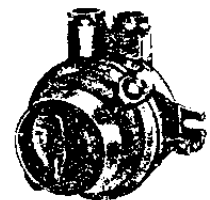
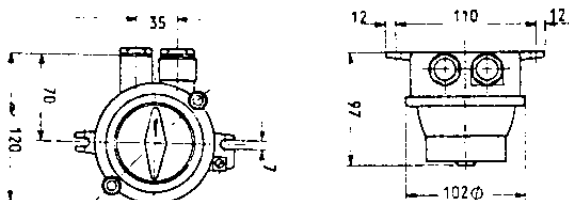

E 14 102/Mn

EUROPEAN ELECTRICAL EQUIPMENT FOR SHIPS

ORDER NO.

EXPLOSION PROOF FIXTURES

Cast brass explosionproof fixture  
for 100W glow lamp

d3209/MS/E27  
○ ¥109,300

" " " " "

d3209/MS/B22  
○ ¥109,300

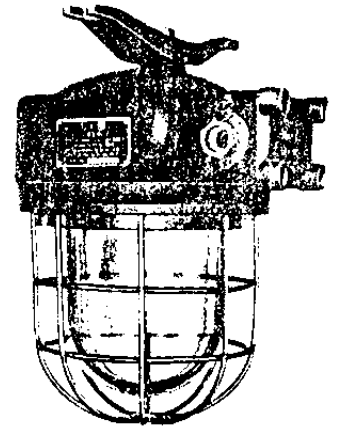

d 3209  
(d 3210)

Explosionproof fixture 60W

505 ¥ 35,900  
○

Cast brass explosionproof fixture  
for 200W glow lamp

d3210/MS/E27  
○ ¥142,950

" " " " "

d3210/MS/B22  
○ ¥142,950

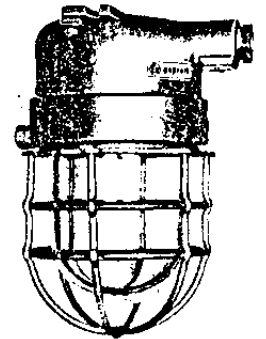

505

BRASS MORSE FIXTURES

Morse fixture with fresnel-lens

1009 ¥ 33,100

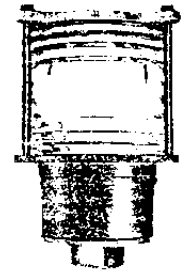

1009

ACCESSORIES

Triangular key M4 for Order No.1009

5500/4 ¥ 1,210

Triangular key M5  
for Order No.E14 102/Mn

5500/5 ¥ 1,410

Triangular key M6  
for Order No.d3209, d3210

5500/6 ¥ 1,650



5500/4 ~6

Lampholder with 2 mounting feet  
E27 for Order No.1009

1974 ¥ 800

Lampholder with 2 mounting feet  
B22 for Order No.1009

1975 ¥ 800

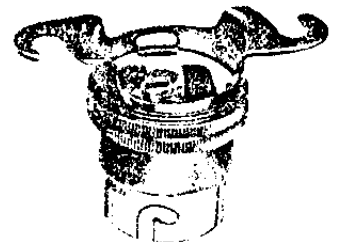

1975

EUROPEAN ELECTRICAL EQUIPMENT FOR SHIPS

ORDER NO.

BRASS STANDARD FIXTURES

Standard fixture  
with unbreakable Makrolon  
globe up to 60W

○ 1131

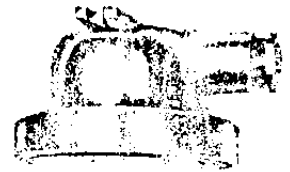

" "

⊗ 1131/2 ¥ 7,360

" "

⊖ 1131/D ¥ 7,360

1131

BRASS DIRECTION LANTERNS

Direction lanterns for 80-100m  
distance to the bow end with  
illuminating point

R1 1/4" 1003 ¥35,300

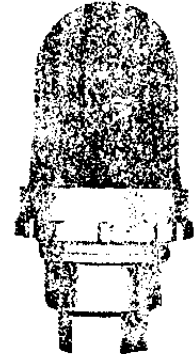

1003

Direction lanterns for more than  
100m distance to the bow end  
with illuminating cross

R1 1/4" 1005 ¥35,300

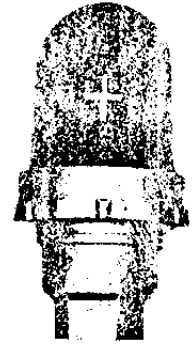

1005

BRASS MORSE KEYS

Morse key, single-pole

⎓ 1010

¥23,700

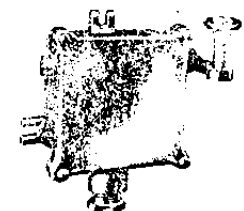

1010

ACCESSORIES

Lampholder with 2 mounting feet  
E27 for Order No.1131

1974 ¥ 800

Lampholder with 2 mounting feet  
B22 for Order No.1131

1975 ¥ 800

Lampholder with 3 mounting feet  
E27 for Order No.1003, 1005

1954 ¥ 800

Lampholder with 3 mounting feet  
B22 for Order No.1003, 1005

1955 ¥ 800

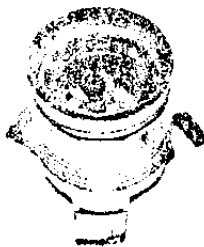

1954



1975

EUROPEAN ELECTRICAL EQUIPMENT FOR SHIPS

ORDER NO.

BRITISH CARGO SOCKETS

Aluminum socket	10A, 250V	4230	¥19,950
Molded compound plug	10A, 250V	4231	¥11,150

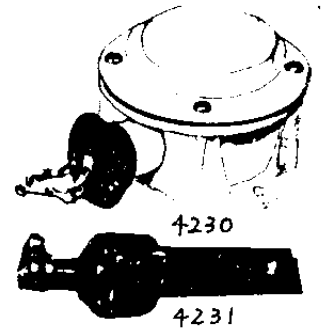

SWEDISH CARGO PLUGS

Brass 3 pin type Swedish cargo plug			
Earth pin male type	10A, 250V	3005	¥ 8,890
Earth pin female type	" "	3006	¥ 8,890
Earth pin male type coupling for Order No.3005		106	¥12,200

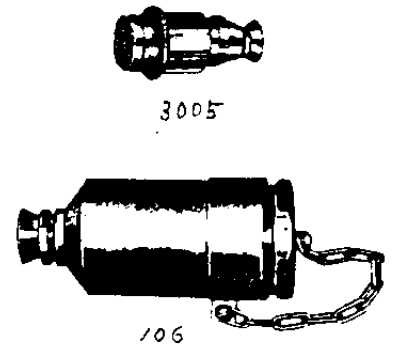

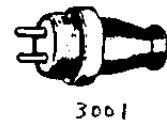

BRASS 2 PIN TYPE SWEDISH CARGO PLUG

Earth pin male type	6A, 250V	3001	¥ 6,360
" " female type	" "	3002	¥ 6,360

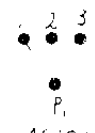

EUROPEAN ROTARY SWITCHES FOR SHIPSPROGRAM SWITCHES 6A

	<u>ORDER NO.</u>		
<b>ON-OFF Switches (0-1)</b>			
1 pole	1C101	¥ 1,960	
2 "	1C201	¥ 2,330	
3 "	1C302	¥ 2,820	
4 "	1C402	¥ 3,180	
<b>Change over switches with-out "Zero" (1-2)</b>			
1 pole	2C101	¥ 2,580	
2 "	2C202	¥ 3,200	
3 "	2C303	¥ 3,550	
<b>Change over switches with "Zero" (1-0-2)</b>			
1 pole	3C101	¥ 2,350	
2 "	3C202	¥ 3,200	
<b>Three way switches with-out "Zero" (1-2-3)</b>			
1 pole	4C102	¥ 2,580	
2 "	4C203	¥ 4,400	
<b>Amper-meter switches</b>			
O-R-S-T	30D304	¥ 4,770	
<b>Volt meter switches (3 phase)</b>			
TR-ST-RS-O-RO-SO-TO	25A403	¥ 4,650	

EUROPEAN ROTARY SWITCHES FOR SHIPS

<u>ROTARY SWITCHES</u>		<u>ORDER NO.</u>	
<u>ON-OFF Switches (O-1-0-1)</u>			
2 pole	16A	C123	¥ 3,670
" "	25A	C225	¥ 4,550
" "	40A	C323	¥10,750
" "	63A	C6H24	¥13,190
" "	125A	C10H26	¥19,200
3 pole	16A	C134	¥ 4,200
" "	25A	C237	¥ 5,500
" "	40A	C334	¥12,100
" "	63A	C6H35	¥16,150
" "	125A	C10H38	¥24,200
" "	250A	C20H311	¥38,590
4 pole	16A	C145	¥ 4,650
" "	25A	C249	¥ 6,360
" "	40A	C345	¥13,570
" "	63A	C6H46	¥18,810
" "	125A	C10H410	¥29,950

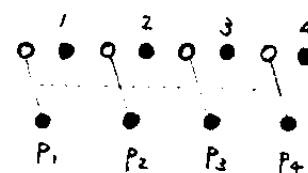
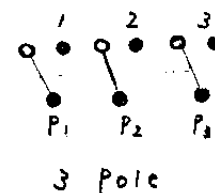
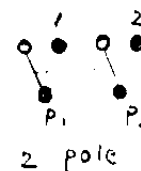
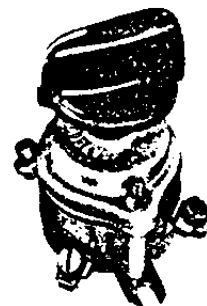

EUROPEAN ROTARY SWITCHES FOR SHIPSORDER NO.ROTARY SWITCHESChange over switches  
with-out "Zero" (1-2-1-2)

2 pole	16A	C125A	¥ 4,650
" "	25A	C225A	¥ 6,970
" "	40A	C325A	¥13,450
" "	63A	C625A	¥16,650

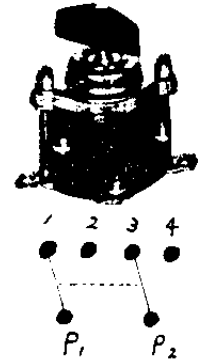

3 pole	16A	C137A	¥ 7,460
" "	25A	C237A	¥ 8,200
" "	40A	C337A	¥16,200
" "	63A	C637A	¥19,300

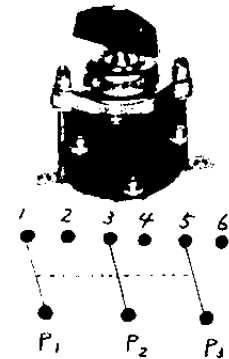
Change over switches  
with "Zero", (1-0-2-0)

1 pole	16A	C113B	¥ 5,100
2 pole	16A	C125B	¥ 5,990
" "	25A	C229B	¥ 8,200
" "	40A	C325B	¥13,690
" "	63A	C629B	¥26,620

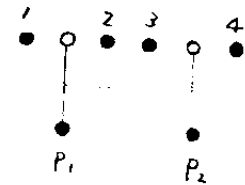
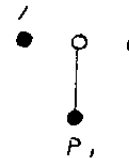

3 pole	16A	C137B	¥ 7,460
" "	25A	C2313B	¥10,650
" "	40A	C337B	¥16,200
" "	63A	C6313B	¥32,200
" "	125A (1-0-2)	C10H313B	¥51,290
" "	250A ( " )	C20H316B	¥55,100

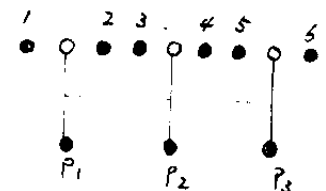

EUROPEAN ROTARY SWITCHES FOR SHIPSORDER NO.ROTARY SWITCHESChange over switches  
with "Zero" (1-0-2-0)

4 pole 40 A

C349B

¥18,100

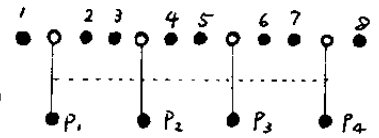
Change over switches  
0-1-(1+2)-2

2 pole 16A

C125GB

¥ 5,280

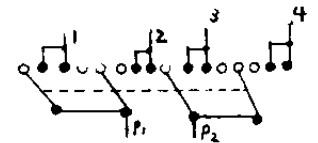
Three way switches  
with "Zero" (0-1-2-3)

3 pole 25A

C2313C

¥ 9,660

" " 40A

C339C

¥18,860

2 pole 40A

C326C

¥19,620.-

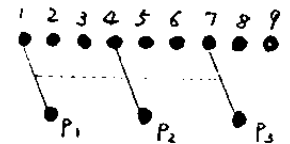
Oven switches  
(0-3-2-1), 0-(A+B par.)-B-(A+B seri.)

1 pole 40A

C314J

¥ 9,200

2 pole 16A

C125J

¥ 5,870

" " 25A

C226J

¥ 7,850

" " 40A

C325J

¥20,300

3 pole 25A

C237-75AH

¥10,650

" " 40A

C337-75AH

¥31,650

3 pole 16A

P16A 9/3

¥ 7,900.-

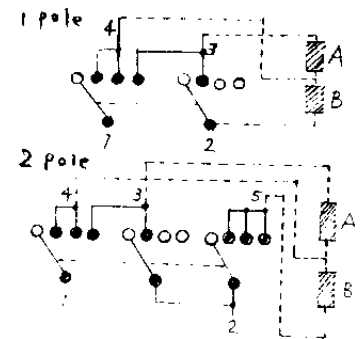

EUROPEAN ROTARY SWITCHES FOR SHIPS

ORDER NO.

ROTARY SWITCHES

Amper-meter switches

(O-R-S-T)	16A	P16A32-3	¥25,650
(O-1-2-3)	16A	P16A33-3	¥12,200

Volt-meter switches

(O-RS-RT-ST)	16A	P16A34-3	¥ 9,050
--------------	-----	----------	---------

PORCELAIN ROTARY SWITCHES

Oven switches

(O-3-2-1), O-(A+B par.)-B-(A+B seri.)

Front connection	2 pole	25A	67008	¥20,670
Back connection	2 pole	25A	67008A	¥20,670
Back connection	2 pole	15A	67007A	¥20,670

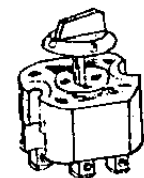
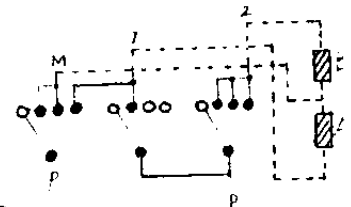

67008A

STAR DELTA SWITCH





(O-Y-Δ-Y)	3 pole	16A	P16A51/3VF1	¥28,050
(O-Y-Δ-Y)	3 pole	25A	P25A51/3VF1	¥31,020

EUROPEAN LAMPHOLDERS FOR SHIPS

( From June 1993

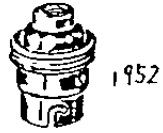
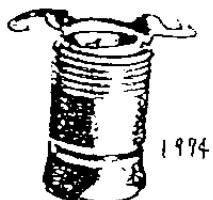
ORDER NO.

LAMPHOLDERS FOR BULB

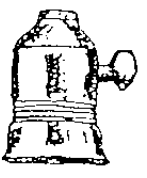
Nipple Lampholder	M10	E14	1982	¥1300	
"	"	E27	1951	¥1050	
"	M13	"	1951-13	¥1250	
"	R3/8"	"	1953	¥1350	
"	"	E40	1973	¥3500	
"	M10	E15	1983	¥1300	
"	"	E22	1952	¥1250	
"	M13	"	1952-13	¥1250	
"	R3/8"	"	1956	¥1250	
Lampholder with mounting feet					
2 mounting feet (Brass)	E14		1984	¥1800	
"	"	E27	1974	¥1300	
"	"	E15	1985	¥1300	
"	"	E22	1975	¥1300	
3 mounting feet (Brass)					
E27			1954	¥1300	
"	"	B22	1955	¥1300	
Nipple lampholder with switch					
Molded compound	M10	E17	61	¥1050	

ORDER NO.

WATERTIGHT LIGHTING FIXTURE

1x20W	60Hz	IP55	220V	11004-004	¥31,570
2x20W	"	"	"	11004-204	¥37,730
1x40W	"	"	"	11004-304	¥39,040
2x40W	"	"	"	11004-404	¥46,630
1x20W	"	"	"	11025-004	¥28,490

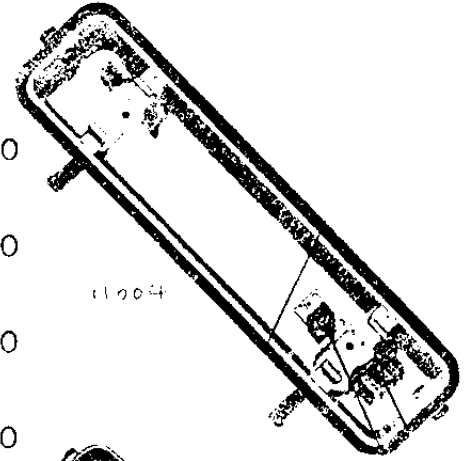

11004

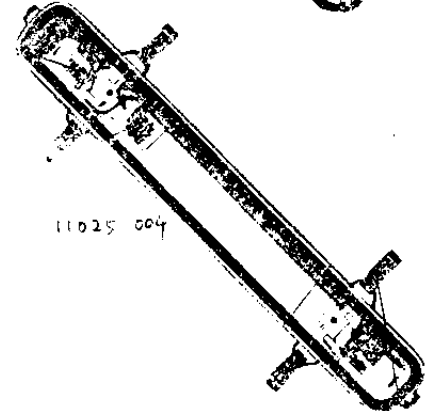

11025-004

CEILING LIGHTING FIXTURE

2x20W(T)	60Hz	IP44	220V	11024-104	¥19,970
2x20W	"	"	"	11024-204	¥28,820
1x40W	"	"	"	11024-304	¥26,730
2x40W	"	"	"	11024-404	¥33,330

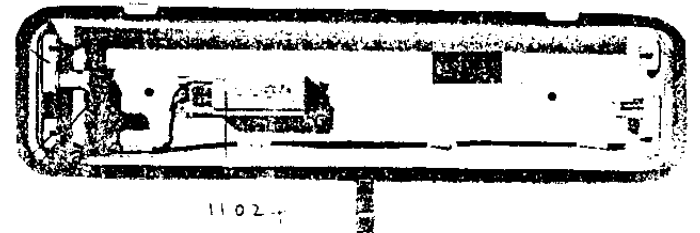

11024

SPARE PARTS

Fluorescent lamp cover

Oblong type

1x20W / 2x20W 960-00088 ¥ 4,150

1x40W / 2x40W 960-00051 ¥11,380

Oval type

1x20W / 2x20W 960-00297 ¥ 9,240

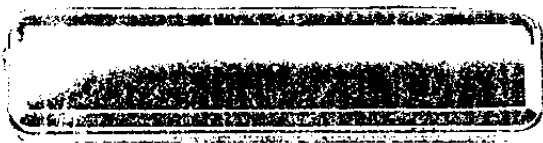

Oblong type

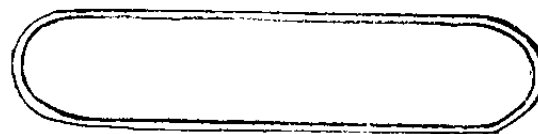

Oval type

(From 1. Apr. 1982)

BALLAST

ORDER NO.

220V, 20W, 60Hz

L-203 ¥5,390

220V, 40W, 60Hz

L-403 ¥5,390

110V, 20W, 60Hz

L-206 ¥5,390

110V, 40W, 60Hz

AROS ¥3,630

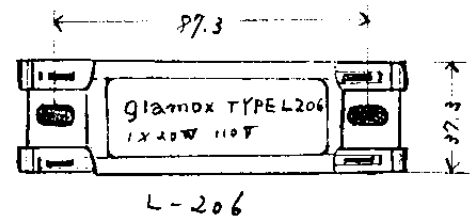

EUROPEAN LAMPHOLDERS FOR SHIPS

ORDER NO.

FLUORESCENT LAMPHOLDERS

Dust and waterproof lampholders  
(for 38mmφ)

SURFACE-MOUNTED FITTING TYPE

Waterproof lampholder 13501 ¥ 2.090

Dustproof lampholder 13503 ¥ 2,310

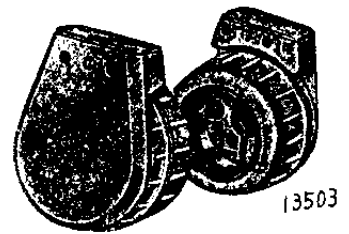

Dust and waterproof lampholders

DOUBLE MOUNT TYPE

Waterproof lampholder 14401 ¥ 4,100

Joint piece 14400 ¥ 860

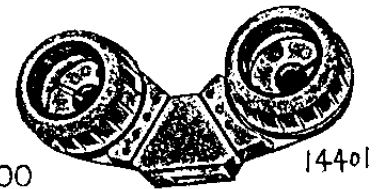

STARTERHOLDER

Screw mounting type

Standard, front connection 09300 ¥ 220

" back " 09301 ¥ 270

Single flat type 48601 ¥ 360

Double " " 48700 ¥ 490

Water proof type 01700 ¥ 660

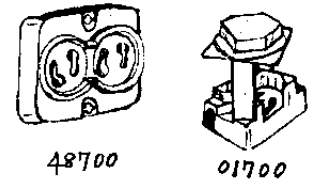
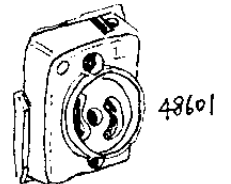

UNIVERSAL STARTER<sup>4W-22W</sup>

S2 ¥ 270

OSRAM Starter 4W - 80W 220V ST111 ¥ 270

PHILIPS Starter 4W - 65W 220V S 10 ¥ 270

OSRAM Safety quick starter 220V ST171 ¥ 1,450

+5°...+80°C for 18W...30W

-20°...+80°C for 32W...65W

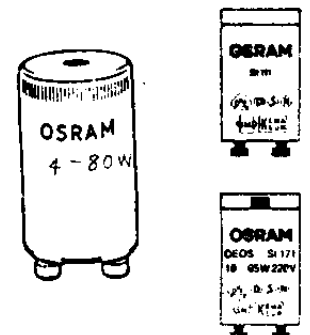

EUROPEAN LAMPHOLDERS FOR SHIPS

ORDER NO.

FLUORESCENT LAMPHOLDER ROUND TYPE

ROTARY MOUNT

with adjusting spring	47002	¥	320
" " "	47102	¥	360
with-out adjusting spring	48500	¥	390
" " " " (with mounting bracket)	48502	¥	530
with adjusting spring	48501	¥	430

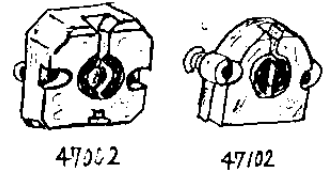

STRAIGHT MOUNT

with-out adjusting spring	46100	¥	600
with adjusting spring	46101	¥	650
with adjusting spring (and mounting bracket)	46103	¥	800



FLUORESCENT LAMPHOLDER SURFACE MOUNTED FITTING TYPE

ROTARY MOUNT TYPE

with-out starterholder	01001	¥	300
with starterholder	01000	¥	470
with-out starterholder	04801	¥	630
with starterholder	04800	¥	690
with-out starterholder	01400	¥	300

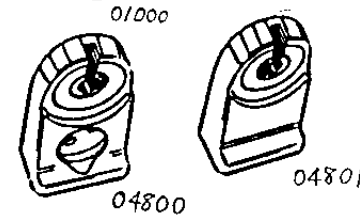
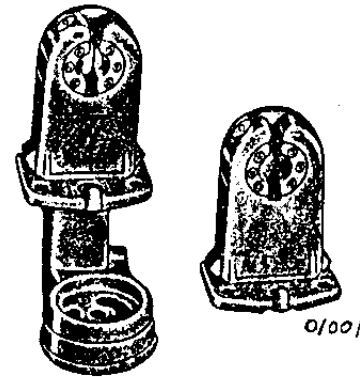

STRAIGHT MOUNT TYPE

with-out starterholder	06005	¥	1,060
with starterholder	06004	¥	1,120
with out starterholder	47106	¥	450
with starterholder	47206 (00171)	¥	750

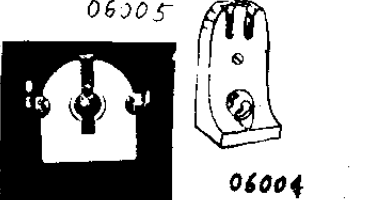
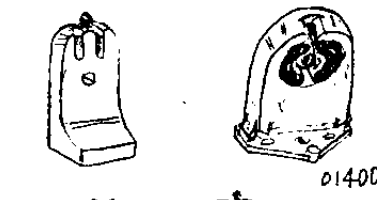

(From 1. Apr. 1982)

EUROPEAN LAMPHOLDERS FOR SHIPS

ORDER NO.

CIRCLE LAMPHOLDERS

(For 32mm $\phi$  tube)

Holder	58001	¥	300
Socket	58016	¥	720



58001

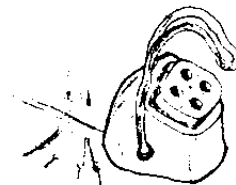

58016

(From 1. Apr. 1982)

ORDER NO.

EUROPEAN SWITCHES, OUTLET AND PLUGS

CONVERTOR PLUGS

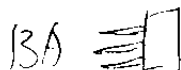

2552  
2555 @ 550



2502-AC

American flat contact 6A, 250V 2502-AC ¥ 250

European round contact " " 2505-CA ¥ 250



2505-CA

2505-AC

BRITISH 3 PIN OUTLETS AND PLUGS

Plug(side cable) 5A, 250V 512 ¥ 200

" 15A, " 513 ¥ 440

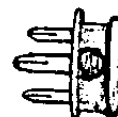

512, 513

Socket 5A, " 532 ¥ 440

" 15A, " 533 ¥ 550



533

FLUORESCENT LAMPHOLDERS

Surface-mounted fitting type

Rotary mount type

with starterholder 01100 ¥ 440

without starterholder 01101 ¥ 220

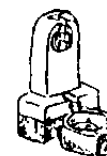













01100

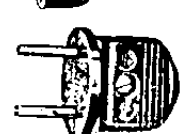

01101

EUROPEAN WALL - OUTLETS AND PLUGS

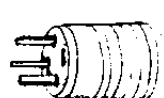
	<u>ORDER NO.</u>			
<u>PROTECTIVE INSIDE - WALL SOCKET 16A, 250V</u>				
Round type single socket	370-UW	¥ 510		370-UW
Square type " "	374-UW	¥ 510		374-UW
" " double socket	<del>370-UW</del> 398-UW	¥ 830		398-UW
Triangle type triple socket	395-UW	¥ 1,430		395-UW
<u>2 PIN OUTLETS AND PLUGS</u>				
Protective contact plug (End cable)	636-W	¥ 250		636-W
Protective contact plug (Side cable)	632-W	¥ 250		632-W
(SCHUKO) Protective contact PVC-plug	56452	¥ 500		56452
" " PVC-coupling	4039W 56552	¥ 730		56552
" " Rubber plug	56438	¥ 930		56438
" " " coupling	56538	¥ 1,410		56538
Wall plug, 2-way, 2 parts	4000	¥ 120		4000
<u>HNA-OUTLETS AND PLUGS 10A, 250V</u>				
Surface mounting socket	35721	¥ 1,320		35721
2 pin with earth protective contact	22130	¥ 1,170		22130

EUROPEAN SWITCHES, OUTLETS AND PLUGS

ORDER NO.

DISTRIBUTION PLUGS 6A, 250V

Three-pin plug  
with rolled pins

700 ¥ 150

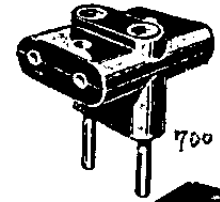

Three-pin plug  
with solid slotted pins

701 ¥ 220



Three-pin plug  
with protective contact

475-W ¥ 770

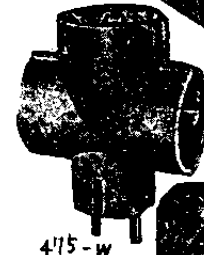

Two-pole pin plug  
with protective contact

472-W ¥ 540



Three-pin plug  
with earth 2x10A + 1x6A

476-W ¥ 910

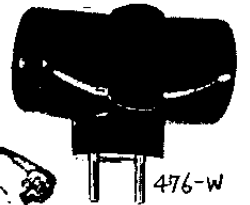

Triangle type  
table socket and plug  
with 1.5M cable

52434 ¥ 2,570



APPLIANCE SOCKETS

10A, 250V, with rocker switch

4025-EW ¥ 900

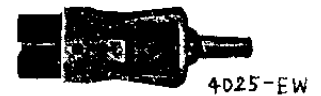

EUROPEAN WALL - SWITCHES, OUTLETS AND PLUGS

ORDER NO.

SPARE PARTS FOR SWITCH AND SOCKET (MERTEN)

Cover plate	1 gang	3971 27	¥ 280
" "	2 "	3972 27	¥ 730
" "	3 "	3973 27	¥ 1,140

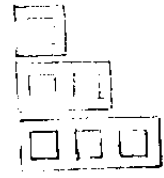

PLUG 10A/16A, 250V (MERTEN)

Plug SCHUKO, large type	1223 27	¥ 660
-------------------------	---------	-------



1223-27

SURFACE MOUNTING SWITCHES 10A, 250V

One-way single pole	4655/1	¥ 1,230
" " double pole	4655/2	¥ 1,980
" " multi circuit	4655/6	¥ 1,320
" " intermediate	4655/7	¥ 2,090
Two " change over	4655/5	¥ 1,590



4655

SURFACE MOUNTING COMBINATION SWITCHES 16A, 250V

One-way single pole	2061/1A	¥ 2,910
" " multi circuit	2061/6A	¥ 2,970
Two " change over	2061/5A	¥ 3,410

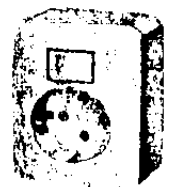

2061

PROTECTIVE OUTSIDE-WALL SOCKET 16A, 250V

Round type single socket	370-AW	¥ 510
Square type " "	374-AW	¥ 510
" " double socket	397-AW	¥ 870
" " triple socket	393-AW	¥ 1,320
Triangle type triple socket	395-AW	¥ 1,980

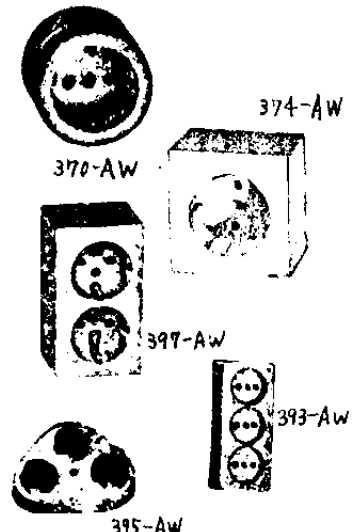

EUROPEAN WALL -SWITCHES, OUTLETS AND PLUGSORDER NO.

=MERTEN=

ROCKER SWITCH AND SOCKET 10A, 250VFlush type

## Rocker switch inserts

One-way 1 pole 3111 44 ¥ 990

" " 2 " 3112 44 ¥ 1,940

Two-circuits 3115 44 ¥ 1,560

Universal one-way/two-way 3116 44 ¥ 1,060

## Rocker control switch inserts

Two-way 3256 44 ¥ 2,350

## Socket outlet SCHUKO

with square centre plate 2744 27 ¥ 630

Double socket outlet SCHUKO  
cover, white 2716 44 ¥ 1,930Socket outlet SCHUKO  
with full cover plate 2704 27 ¥ 470Surface type

## Rocker switch

Universal one-way/two-way 3006 27 ¥ 1,270

Two-circuits 3005 27 ¥ 1,780

One-way, 2 pole 3002 27 ¥ 2,150

Socket outlet SCHUKO-double- 2760 27 ¥ 1,190

Socket outlet SCHUKO-single- 2750 27 ¥ 700



3112-44



3256-44



2744-27

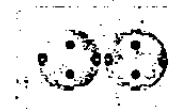

2716-44



2704-27



3006-27



2760-27



2750-27

EUROPEAN WIRING EQUIPMENTS

ORDER NO.

MOLDED COMPOUND JUNCTION BOXES

<u>Pole</u>	<u>Nominal section(mm<sup>2</sup>)</u>	<u>Dimension(mm)</u>				
4	2.5	58 x 58 x 28	57244	¥	310	
5	"	" " "	57245	¥	350	

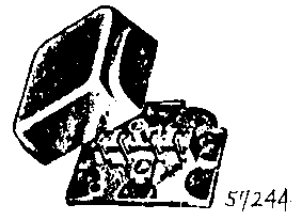

PLASTIC TERMINAL STRIPS

Flexible, square,  
12 way with unloosable screw

<u>Amp.</u>	<u>Nominal section(mm<sup>2</sup>)</u>	<u>Dimension(mm)</u>				
16A	4	113 x 12 x 15	3512-P	¥	180	
10A	2.5	95 x 16 x 13	2512-P	¥	210	
20A	6	117 x 20 x 15	3012-P	¥	220	
25A	10	134 x 25 x 18	3112-P	¥	370	
35A	16	173 x 28 x 21	3212-P	¥	720	
50A	25	213 x 37 x 28	3312-P	¥	2,420	

Handwritten notes: 1120, 1120, 1120, 1120

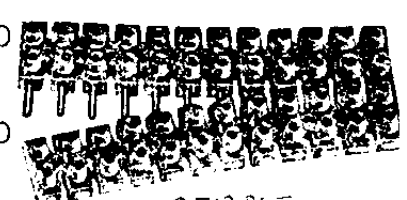
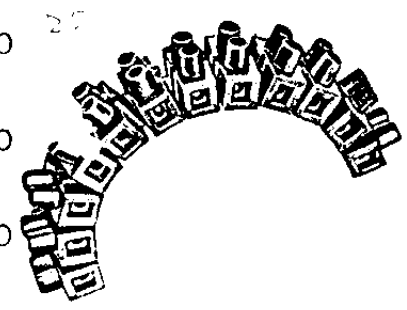

2512 PST  
3012 PTST  
3112 PST

International type

10A	2.5	117 x 20 x 17	3012-PTN	¥	540	
-----	-----	---------------	----------	---	-----	--

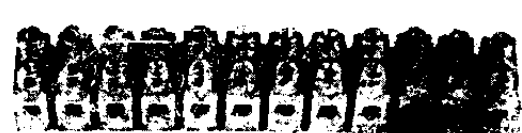

Handwritten mark: 4-3111

EUROPEAN WIRING EQUIPMENTS

ORDER NO.

TERMINAL STRIPS

Pressed material

<u>Amp.</u>	<u>Nominal section(mm<sup>2</sup>)</u>	<u>Dimension(mm)</u>
-------------	--	----------------------

*E-11/1947*

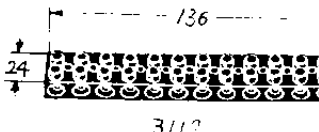
16A	4	142x12x16	3512	¥	200	 3512
10A	2.5	113x16x12	3012-K	¥	320	
25A	10	136x24x17	3112	¥	540	
35A	16	177x29x22.5	3212	¥	880	

FIXING TERMINAL STRIPS

Pressed material

10A	2-pole	2.5mm <sup>2</sup>	21.5x19x15.5	3002-Z	¥	80
10A	4-pole	"	38x20x15.5	3004-Z	¥	140

*20/2*



PORCELAIN LUSTER TERMINALS, GLAZED

16A	1-pole	4mm <sup>2</sup>	22x10x16	351	¥	50
16A	"	"	17x9x12	351-Z	¥	60
16A	2-pole	"	22x19x16	352	¥	100
16A	3-pole	"	27x21x16	353	¥	130
35A	1-pole	16mm <sup>2</sup>	30x15x24	356	¥	130
35A	2-pole	"	30x26x23	357	¥	220

3004-Z

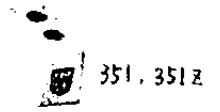



EUROPEAN WIRING EQUIPMENTS

ORDER NO.

PORCELAIN LUSTER TERMINALS, GLAZED

with central fixing hole

AMP.      Nominal section(mm<sup>2</sup>)      Dimension(mm)

16A 2-pole	4	21x20x15	354	¥	100		354
16A 3-pole	"	35x20x17	355	¥	160		355

PORCELAIN LUSTER TERMINAL, SQUARE

16A 1-pole	4	14x13x17	920	¥	60		920
------------	---	----------	-----	---	----	---	-----

EUROPEAN WIRING EQUIPMENTSORDER NO.TERMINAL BLOCKS

Terminal blocks

<u>Nominal section(mm<sup>2</sup>)</u>	<u>Dimension(mm)</u>			
2.5	32x46x5	54003-0053	¥	210
4	32x46x6	54004-0053	¥	170
10	38x55.5x8	54010-0053	¥	260
16	43x59x10	54016-0053	¥	370
25	53x66x12	54025-0053	¥	570
35	53x66x16	54035-0053	¥	620

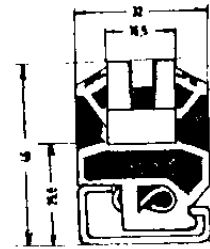

54003-0053

Cover plates for

2.5 - 4	32x46x1.5	07310-3153	¥	60
10	38x55.5x2	07310-3253	¥	80
16	43x59x2	07310-3953	¥	80
25 - 35	53x66x2	07310-3353	¥	90



07310-3153

Special separators for

2.5 - 4	40x50x1.5	07310-3453	¥	90
10	46x59.5x2	07310-3553	¥	90
16	51x63x2	07310-4053	¥	100
25 - 35	61x70x2	07310-3653	¥	110

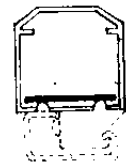

07310-3453

EUROPEAN WIRING EQUIPMENTSORDER NO.TERMINAL BLOCKS

Copper connecting strips (x600mm)  
for

Nominal section(mm<sup>2</sup>)    Dimension(mm)

2.5	Z7215-0027	¥1,280
4	Z7211-0027	¥1,160
10	Z7212-0027	¥1,370
16	Z7214-0027	¥1,760
25	Z7213-0027	¥2,930
35	Z7216-0027	¥3,660

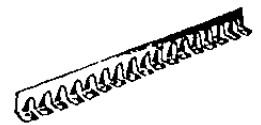

Z 7211-0027

Connection bars with 2 screws  
for

2.5	Z7269-3523	¥ 140
4	Z7269-2923	¥ 150
10	Z7269-3023	¥ 160
16	Z7269-3123	¥ 160
25	Z7269-3223	¥ 180
35	Z7269-3423	¥ 190

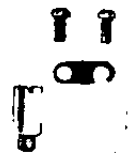

Z 7269-2923



Z5522-1321

End stoppers wide 5mm

" " " 10mm

Bus-bar            15x32x900mm            98190-0000            ¥1,100



Z5522-2423



EUROPEAN WIRING EQUIPMENTSORDER NO.BRASS CABLE GLANDS

Brass cable screw glands

<u>External thread(mm)</u>	<u>Cable external Diameter up to(mm)</u>			
M18 x 1.5	8.5	KVM 18-Z8	¥	930
" "	10.5	KVM 18-Z10	¥	970
M24 x 1.5	8.5	KVM 24-Z8	¥	840
" "	10.5	KVM 24-Z10	¥	840
" "	12.5	KVM 24-Z12	¥1,100	
" "	14.5	KVM 24-Z14	¥1,100	
" "	17.5	KVM 24-Z17	¥1,100	



KVM 24-Z10

Brass cable screw glands  
with Pg connection thread

<u>External thread(Pg)</u>	<u>Thread outside Diameter</u>			
7	12.5	27070	¥	300
9	15.2	27071	¥	350
11	18.6	27072	¥	380
13.5	20.4	27073	¥	420
16	22.5	27074	¥	500
21	28.3	27075	¥	550
29	37	27076	¥	600



EUROPEAN WIRING EQUIPMENTSORDER NO.BRASS CABLE GLANDS

Brass cable screw glands  
with Pg connection thread

External thread(Pg)      Thread outside  
Diameter (mm)

36	47	27077	¥ 860	
42	54	27078	¥1,910	
48	59.9	27079	¥2,590	

Brass lock nuts	M18x1.5	GM-18	¥ 150	
-----------------	---------	-------	-------	--

" " "	M24x1.5	GM-24	¥ 160	 GM-24
-------	---------	-------	-------	--

" " "	M30 x 2	GM-30	¥ 280
-------	---------	-------	-------

Brass stop ends	M24 x 1.5	VSM-24	¥ 490	 VSM-24
-----------------	-----------	--------	-------	---

" " "	M30 x 2	VSM-30	¥ 770
-------	---------	--------	-------

Terminal block with fuse		52016-1040	¥ 980	
--------------------------	--	------------	-------	--

" " " "		52016-2040	¥1,050	
---------	--	------------	--------	---

" " " "		52016-1140	¥1,680
---------	--	------------	--------

Cap for holder		06502-1700	¥ 560	
----------------	--	------------	-------	---

(From 1. Apr. 1982)

EUROPEAN WIRING EQUIPMENTS

ORDER NO.

PLASTIC CLIP FOR ROUND CABLE

Cable external diameter (mm)

4 - 7 mm	WB 7/25	¥ 10
5 - 7 mm	2722/20	¥ 10
7 - 11 mm	WB 11/35	¥ 15
10 - 13.5mm		¥ 20
10 - 14 mm	WB 14/40	¥ 20 → N 3.9
13.5 - 17 mm	2725/40	¥ 30
<del>16 mm</del>	<del>402516</del>	<del>¥ 25</del>
18 mm (16~21)	402518	¥ 30
21 mm	402521	¥ 40

PLASTIC CLIPS FOR FLAT CABLE

5 x 3.5 mm	4057-5	¥ 8
7 x 4 mm	4055-7	¥ 10
10 x 6 mm	4055-10	¥ 10

ETC.

ORDER NO.

BULBS

Pilot lamp

24-30V, 1W	5φ x 20mm	45032-3	¥ 590
2.25V, 0.25A E10	9φ x 24mm	44090	¥ 210
3.7V 0.3A "	9φ x 24mm	44094	¥ 320

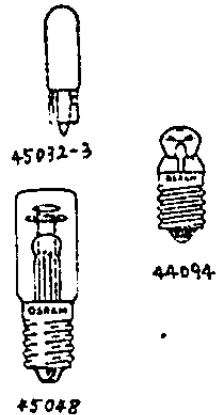

Neon lamp

220V,	E14	16.5φ x 54mm	45048	¥ 920
-------	-----	--------------	-------	-------

Morse lamp

24V, 100W	Ba20d	59φ x 83mm	40054	¥11,550
" "	"	50φ x 74mm	40061	¥ 6,710
12V, 60W	B15	42.5φ x 64mm	3025	¥ 880

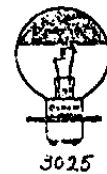
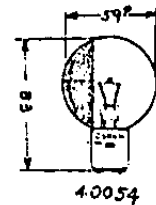

Incandiscent lamp

220V, 75W	E27	60φ x 105mm	37014	¥ 610
-----------	-----	-------------	-------	-------



Glass lamp

6-7V, 30mA			45031-1	¥ 220
------------	--	--	---------	-------

Navigation lamp

24V, 40W, P28s	38φ x 106mm			¥ 3,800
----------------	-------------	--	--	---------

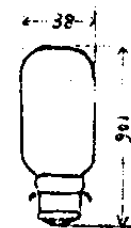

Concentra Lamp

150W, 235V, E27		143148	¥ 3,960.-
-----------------	--	--------	-----------

ETC.

ORDER NO.

BATTERIES

4.5V	Dimension: 62x22x67mm	69014	¥ 500
3V	" 21.5øx74mm	69028	¥ 360



LIMIT SWITCH 10A, 600V

With box	64x43x114mm	K244gR-2S	¥3,940
Interior switch, double		K244xP-2S	¥2,640
"	" triple	3SE1002	¥9,680
"	" (THRIGE-TITAN A/S) 2358 124 x 104mm		¥18,250
"	" (THRIGE-TITAN A/S) 2358/3		¥21,570

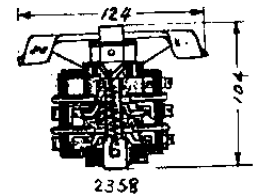
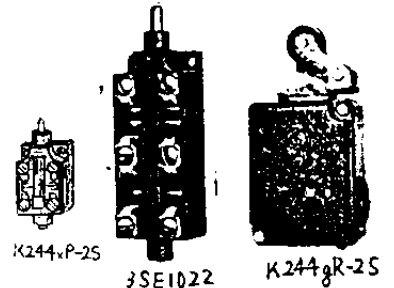

PUSH BUTTON SWITCHES 2A, 250V

French type push button switch	246-L	¥ 160
Free type push button switch (DANSKE SECURITAS A/S) mounting hole: 18ø	101102	¥1,930

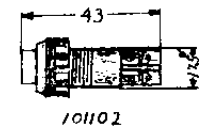
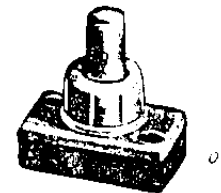

HAND LAMPS

Molded compound material with porcelain lampholder E27	32081	¥8,720
---	-------	--------



ETC.

ORDER NO.

TOOLS

Soldering iron	8W, 220V, long 180mm	62056	¥ 7,320
"	" 16W, 220V. long 230mm	62057	¥ 7,320
"	" 30W, 220V	62058	¥ 5,440
Voltage tester	110-500V, long 144mm	6157	¥ <del>300</del> <sup>500</sup>
"	" 110-750V (DUSPOL)	63041	¥ <del>10,330</del> ¥ 12,500
Flexible test probe	long 155mm Red	18054	¥ 950
"	" " " " Black	18055	¥ 950
Plug for laboratories	14x54x70mm	3982	¥ 750
Alligator clip with insulation	Red	18039	¥ 880
"	" " " " Black	18040	¥ 880
Testing wire with plug connection			
	Red	18050	¥ 630
"	" " " " Black	18051	¥ 630
Pilot wire with banana pin & tube			
100mm length	Red	71012	¥ 2,260
"	" " " " Black	71014	¥ 2,260

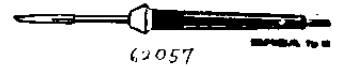

62057



6157



63041



18054



3982



18039

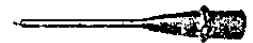

18050